



GAS INSERTS

DIRECT VENT GAS FIREPLACE INSERTS



regency-fire.com

WHY CHOOSE REGENCY?

At Regency, our past 40 years have been focused on providing a high-level of service while building high-quality and reliable products that our customers can enjoy for years to come.

HIGH-QUALITY

Producing a high-quality product has been at the very heart of what we do from when that very first stove rolled off the production line over 40 years ago to today. We are ever-focused on producing quality products for our customers that will last for years to come.

BEST WARRANTY

A fireplace should be reliable and should work right the first time it is used, and the 1,000th. A core part of our business is making sure that we are building long-lasting, durable, high-quality products; we back-up that commitment with the industry's best warranty on all our products.

COST-EFFICIENT

Never before have home heating costs been higher. Turn your furnace way down and zone heat with our beautiful, reliable and convenient Regency products. Not only can you cut your fuel bills in half, but you'll be able to enjoy the timeless comfort of a Regency fire.

Why Regency? Because it's **more** than a fireplace!



TABLE OF CONTENTS

Regency Liberty® Radiant Gas Inserts	
Regency Horizon® Radiant Gas Inserts	
LRi3E	04
HRi3E	06
LRi4E	08
HRi4E	10
LRi6E	12
HRi6E	14
Regency Energy™ Standing Pilot Gas Inserts	
Regency Liberty® Standing Pilot Gas Inserts	
E33	16
U31	18
L234	20
Backing Plates, Faceplates & Inlays	22
Accessories	25
Specifications	28



REGENCY LIBERTY® RADIANT LRi3E

Compact Gas Fireplace Insert



LRi3E shown with Vignette faceplate in Black and Rustic Brown interior panels.



Small backing plate and Vignette faceplate in Platinum



Regular backing plate and Vignette faceplate in Tuscan Sunset



Arched backing plate and arched Vignette faceplate in Black

COMPACT AND EFFICIENT

Regency is proud to present the newest addition to the Liberty gas insert family, now available in a smaller size to fit a larger array of spaces. Enjoy timeless, artisan-crafted logs with the combined power of radiant & convective heat. Vignette designer faceplates provide you with the choice to create a modern transitional look or a traditional look with Georgian & Tudor styles.

SPECIFICATIONS	NATURAL GAS	PROPANE
Input (BTU)	20,500	19,000
Turn down to (BTU)	14,000	15,500
Efficiency (steady state)	73.12%	74.59%
EnerGuide Rating (Canada only)	66.25%	66.70%

MINIMUM FIREPLACE OPENING (VIGNETTE FACEPLATE)	
Width (front)	28-1/2"
Width (rear)	21-5/8"
Height	19-1/2"
Depth	14-1/2"



LR13E shown with 4-sided regular backing plate and Vignette faceplate in Platinum.



Regular backing plate, Vignette faceplate in Black and Craftsman inlay in Black Chrome

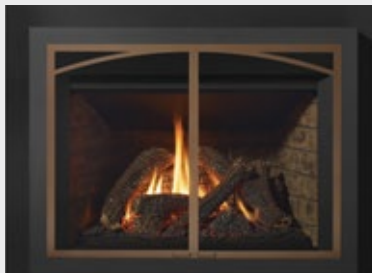

Regular backing plate, Vignette faceplate in Black and Door inlay in Tuscan Sunset



Regular backing plate and Vignette Georgian faceplate in Black

STANDARD FEATURES

- Natural gas
- Safety screen with ceramic safety glass
- High definition 7 piece log set with ceramic burner and glowing ember bed
- Proflame II GTMF remote control system
- Variable speed blower for max heat distribution
- 30° angled flue for versatile installation
- Direct vent
- Limited lifetime warranty

OPTIONS

- Vignette faceplates in various designs and colors
- Vignette inlays in various designs and colors
- Interior panels in Old Town Red, Rustic Brown or Volcanic Black
- Reflective black enamel interior panels
- Small, regular, arched, oversized and custom backing plates
- Hearth trim kit and mantel deflector
- Regency flex liners
- Propane conversion kit

REGENCY HORIZON® RADIANT HRi3E

Compact Gas Fireplace Insert



HRi3E shown with Vignette faceplate in Black, Black Crystals with Volcanic Stones and Black Reflective Enamel panels.



Small backing plate and Vignette faceplate in Black Chrome with Starfire Crystals



Arched backing plate and arched Vignette faceplate in Black with optional volcanic stones



4-sided regular backing plate and Vignette faceplate in Platinum with Black Crystals

COMPACT AND CUSTOMIZABLE

Designed for contemporary spaces, the HRi3E is as versatile as it is beautiful. The HRi3E gas insert delivers heat efficiently and with a captivating style. Choose the look you want with a wide selection of accent options. Colored glass crystals or firebeads combine elegantly with spa stones or driftwood logs.

SPECIFICATIONS	NATURAL GAS	PROPANE
Input (BTU)	19,500	19,000
Turn down to (BTU)	14,000	15,500
Efficiency (steady state)	71.73%	72.87%
EnerGuide Rating (Canada only)	64.36%	66.24%

MINIMUM FIREPLACE OPENING (VIGNETTE FACEPLATE)	
Width (front)	28-1/2"
Width (rear)	21-5/8"
Height	19-1/2"
Depth	14-1/2"



HRI3E shown with regular backing plate, Vignette faceplate in Platinum with Black Crystals and optional Driftwood log set.



Regular backing plate, Vignette faceplate in Black, Craftsman inlay in Black Chrome with Black Crystals and optional Driftwood log set



Regular backing plate, Vignette faceplate in Black, Door inlay in Tuscan Sunset with Black Crystals and optional Volcanic Stones



Regular backing plate, Vignette Tudor faceplate in Black with Black Crystals and optional Volcanic Stones

STANDARD FEATURES

- Natural gas
- Safety screen with ceramic safety glass
- Regency Horizon contemporary linear fire bed with black steel interior panels
- Proflame II GTMF remote control system
- Variable speed blower for max heat distribution
- 30° angled flue for versatile installation
- Direct vent
- Limited lifetime warranty

OPTIONS

- Vignette faceplates in various designs and colors
- Vignette inlays in various designs and colors
- Firebeads and crystals in various colors
- Driftwood log set, Volcanic Stones, Spa Stones or River Pebbles
- Reflective black enamel interior panels
- Small, regular, arched, oversized and custom backing plates
- Hearth trim kit and mantel deflector
- Regency flex liners
- Propane conversion kit

REGENCY LIBERTY® RADIANT LRi4E

Medium Gas Fireplace Insert



LRi4E shown with regular backing plate, Vignette faceplate in Black, Door Inlay in Black and Rustic Brown Brick Panels.



Small backing plate and Vignette faceplate in Platinum



Regular backing plate and Vignette faceplate in Tuscan Sunset



4-sided regular backing plate and Vignette faceplate in Black

PERFORMANCE AND STYLE

The Liberty Radiant LRi4E gas insert exemplifies Regency's renowned commitment to quality. A source of both radiant and convective heat, the LRi4E delivers high-efficiency heat safely and reliably throughout your home. Turn on the integrated circulating fan to intensify the warming effect. This statement fireplace can be customized with Regency's selection of accent trim options.

SPECIFICATIONS	NATURAL GAS	PROPANE
Input (BTU)	31,000	31,000
Turn down to (BTU)	22,000	26,000
Efficiency (steady state)	71.45%	73.01%
EnerGuide Rating (Canada only)	70.27%	69.36%

MINIMUM FIREPLACE OPENING (VIGNETTE FACEPLATE)	
Width (front)	30"
Width (rear)	22"
Height	20"
Depth (without spacer)	18"
Depth (with spacer)	15-3/4"



LR14E shown with arched backing plate and decorative arched Vignette faceplate in Black.



Regular backing plate, Vignette faceplate in Black and Craftsman inlay in Black Chrome



Regular backing plate, Vignette faceplate in Black and Door inlay in Tuscan Sunset



Regular backing plate and Vignette Georgian faceplate in Black

STANDARD FEATURES

- Natural gas
- Safety screen
- Ceramic safety glass
- High definition log set
- Ceramic burner with glowing ember bed
- Electronic ignition with SureFire™ switch
- Proflame I GTMF remote control
- Variable speed blower for max heat distribution
- 6-tube heat exchanger for max efficiencies
- 30° angled flue for versatile installation
- Direct vent
- Limited lifetime warranty

OPTIONS

- Vignette faceplates in various designs and colors
- Vignette inlays in various designs and colors
- Faceplate spacer for shallow fireplace installations
- Interior panels in Old Town Red, Rustic Brown or Volcanic Black
- Reflective black enamel interior panels
- Small, regular, arched, oversized and custom backing plates
- Mantel deflector for reduced clearances
- Hearth trim kits for raised hearth installations
- Wall thermostat
- Regency flex liners
- Propane conversion kit

REGENCY HORIZON® RADIANT HRi4E

Medium Gas Fireplace Insert



HRi4E shown with 4-sided regular backing plate, Vignette faceplate in Platinum with Black Crystals and optional Driftwood log set.



Small backing plate and Vignette faceplate in Black with Black Crystals and optional Driftwood log set



Arched backing plate and arched Vignette faceplate in Black with optional Starfire Crystals



Regular backing plate and Vignette faceplate in Black with optional Black Crystals

MODERN AND ELEGANT

Add comfort and update the look of your home with a Regency Horizon Radiant medium-sized gas insert. Radiant inserts deliver heat efficiently and can be customized with captivating firebed options. Simply choose the style you want: combine colored glass crystals or firebeads with spa stones for natural elegance or select driftwood logs for a coastal look.

SPECIFICATIONS	NATURAL GAS	PROPANE
Input (BTU)	31,000	31,000
Turn down to (BTU)	22,000	26,000
Efficiency (steady state)	71.45%	73.01%
EnerGuide Rating (Canada only)	70.27%	69.36%

MINIMUM FIREPLACE OPENING (VIGNETTE FACEPLATE)	
Width (front)	30"
Width (rear)	22"
Height	20"
Depth (without spacer)	18"
Depth (with spacer)	15-3/4"



HRI4E shown with regular backing plate, Vignette faceplate in Platinum and Black Crystals.



Regular backing plate, Vignette faceplate in Black, Craftsman inlay in Black Chrome with Black Crystals and optional Volcanic Stones



Regular backing plate, Vignette faceplate in Black and Door inlay in Tuscan Sunset with Black Crystals



Regular backing plate and Vignette Tudor faceplate in Iron Grey with Black Crystals

STANDARD FEATURES

- Natural gas
- Safety screen
- Ceramic safety glass
- Ceramic burner with glowing ember bed
- Electronic ignition with SureFire™ switch
- Proflame I GTMF remote control
- Variable speed blower for max heat distribution
- 6-tube heat exchanger for max efficiencies
- 30° angled flue for versatile installation
- Direct vent
- Limited lifetime warranty

OPTIONS

- Vignette faceplates in various designs and colors
- Vignette inlays in various designs and colors
- Faceplate spacer for shallow fireplace installations
- Driftwood log set, crystals or firebeads in various colors
- Volcanic Stones, Spa Stones, or accent River Pebbles
- Reflective black enamel interior panels
- Small, regular, arched, oversized and custom backing plates
- Mantel deflector for reduced clearances
- Hearth trim kits for raised hearth installations
- Wall thermostat
- Regency flex liners
- Propane conversion kit

REGENCY LIBERTY® RADIANT LRi6E

Large Gas Fireplace Insert



LRi6E shown with decorative arched Vignette and arched backing plate in Black.



Small backing plate and Vignette faceplate in Tuscan Sunset



Regular backing plate and Vignette faceplate in Black



4-sided regular backing plate and Vignette faceplate in Platinum

RADIANT CONVECTIVE HEAT

This large, high-efficiency heater provides intense radiant heat instantly. Enjoy strong heat in the area directly in front of your fireplace or turn on the included heat circulating blower to distribute comforting warmth into the far corners of your room. The Regency Liberty LRi6E large gas insert is a stylish, reliable source of warmth and ambiance, even during a power outage.

SPECIFICATIONS	NATURAL GAS	PROPANE
Input (BTU)	38,000	38,000
Turn down to (BTU)	25,000	30,000
Efficiency (steady state)	73.01%	73.01%
EnerGuide Rating (Canada only)	70.37%	70.37%

MINIMUM FIREPLACE OPENING (VIGNETTE FACEPLATE)	
Width (front)	34"
Width (rear)	25"
Height	24"
Depth (without spacer)	19-1/2"
Depth (with spacer)	16-3/4"



LRi6E shown with regular backing plate, Vignette faceplate in Black, Craftsman inlay in Tuscan Sunset.



Regular backing plate, Vignette faceplate in Black, Door inlay in Black Chrome



Regular backing plate, Vignette Tudor faceplate in Iron Grey



Regular backing plate, Vignette faceplate in Black, Door inlay in Tuscan Sunset

STANDARD FEATURES

- Natural gas
- Safety screen
- Ceramic safety glass
- High definition log set
- Ceramic burner with glowing ember bed
- Black steel interior panels
- Electronic ignition with SureFire™ switch
- Proflame I GTMF remote control
- Variable speed blower for max heat distribution
- 6-tube heat exchanger for max efficiencies
- 30° angled flue for versatile installation
- Direct vent
- Limited lifetime warranty

OPTIONS

- Vignette faceplates in various designs and colors
- Vignette inlays in various designs and colors
- Faceplate spacer for shallow fireplace installations
- Interior panels in Old Town Red, Rustic Brown or Volcanic Black
- Reflective black enamel interior panels
- Small, regular, arched, oversized and custom backing plates
- Mantel deflector for reduced clearances
- Hearth trim kits for raised hearth installations
- Wall thermostat
- Regency flex liners
- Propane conversion kit

REGENCY HORIZON® RADIANT HRi6E

Large Gas Fireplace Insert



HRi6E shown with regular backing plate, Vignette faceplate in Black Chrome, Black Crystals with Volcanic Stones and Black Reflective Enamel panels.



Small backing plate, Vignette faceplate in Platinum with Black Crystals and optional Volcanic Stones



Arched backing plate, arched Vignette faceplate in Black with Black Crystals and optional Driftwood log set



4-sided regular backing plate, Vignette faceplate in Black Chrome with Black Crystals

SLEEK AND CONTEMPORARY

The Regency Horizon Radiant Series introduces a sleek, contemporary large gas insert designed to transform your existing fireplace. Choose from a selection of modern Vignette faceplates and firebed options to create a unique look. Backed by the industry's best warranty, the HRi6E provides reliable, high-efficiency heat with exceptional styling.

SPECIFICATIONS	NATURAL GAS	PROPANE
Input (BTU)	38,000	38,000
Turn down to (BTU)	25,000	30,000
Efficiency (steady state)	73.01%	73.01%
EnerGuide Rating (Canada only)	70.37%	70.37%

MINIMUM FIREPLACE OPENING (VIGNETTE FACEPLATE)	
Width (front)	34"
Width (rear)	25"
Height	24"
Depth (without spacer)	19-1/2"
Depth (with spacer)	16-3/4"



HRI6E shown with regular backing plate, Vignette faceplate in Black Chrome with Black Crystals and optional Driftwood log set.



Regular backing plate, Vignette faceplate in Black and Door inlay in Black Chrome with Starfire Crystals



Regular backing plate, Vignette faceplate in Black and Craftsman inlay in Black Chrome with Black Crystals



Regular backing plate, Vignette Tudor faceplate in Black with Black Crystals and optional Volcanic Stones

STANDARD FEATURES

- Natural gas
- Safety screen
- Ceramic safety glass
- Ceramic burner with glowing ember bed
- Black steel interior panels
- Electronic ignition with SureFire™ switch
- Proflame I GTMF remote control
- Variable speed blower for max heat distribution
- 6-tube heat exchanger for max efficiencies
- 30° angled flue for versatile installation
- Direct vent
- Limited lifetime warranty

OPTIONS

- Vignette faceplates in various designs and colors
- Vignette inlays in various designs and colors
- Faceplate spacer for shallow fireplace installations
- Driftwood log set, crystals or firebeads in various colors
- Volcanic Stones, Spa Stones, or Accent River Pebbles
- Reflective black enamel interior panels
- Small, regular, arched, oversized and custom backing plates
- Mantel deflector for reduced clearances
- Hearth trim kits for raised hearth installations
- Wall thermostat
- Regency flex liners
- Propane conversion kit

REGENCY ENERGY™ E33

Large Gas Fireplace Insert



E33 shown with Low Profile faceplate and brick panels.

AN ATTRACTIVE HEAT SOURCE

The E33 large gas fireplace insert is a high-efficiency heat source that is designed to seal old drafty fireplaces and provide controllable gas heat. With a standard variable-speed blower, the E33 helps circulate air within the room, distributing it further than radiant heat alone. This unit is a sealed system that uses outside air for combustion – making it perfect for airtight homes.

SPECIFICATIONS	NATURAL GAS	PROPANE
Input (BTU)	38,000	35,500
Turn down to (BTU)	20,000	19,000
Efficiency (steady state)	70.14%	70.73%
EnerGuide Rating (Canada only)	60.70%	61.49%

MINIMUM FIREPLACE OPENING (VIGNETTE FACEPLATE)	
Width (front)	32-1/4"
Width (rear)	25"
Height	24"
Depth (without spacer)	18"
Depth (with spacer)	16-3/4"



E33 shown with Vignette faceplate in Black, Door inlay in Tuscan Sunset and brick panels.



Vignette faceplate in Black



Vignette faceplate in Black and Door inlay in Black Chrome



Vignette faceplate in Black and Door inlay in Black

STANDARD FEATURES

- Natural gas
- Safety screen
- Ceramic safety glass
- Proflame I GTM remote control
- Log set with glowing embers
- Flame height adjustment control
- Variable speed blower
- 30° angled flue for versatile installations
- Standing pilot system
- Direct spark ignition
- Limited lifetime warranty

OPTIONS

- Faceplates in low profile or Vignette design
- Vignette door inlay in various colors
- Custom backing plate
- Brick panels
- Wall thermostat
- Installation spacer
- Regency flex liners
- Propane conversion kit

REGENCY ENERGY™ U31

Medium Gas Fireplace Insert



U31 shown with Low Profile faceplate and brick panels.

CUSTOMIZE TO SUIT YOUR STYLE

These Regency inserts are a complete fireplace system that can turn your existing wood fireplace into a high efficiency, clean-burning gas heater. Enjoy peace of mind even during power outages; all Regency gas inserts operate safely and effectively without electricity. Stay warm, no matter what!

SPECIFICATIONS	NATURAL GAS	PROPANE
Input (BTU)	30,000	28,000
Turn down to (BTU)	20,600	22,000
Efficiency (steady state)	58.45%	59.29%
EnerGuide Rating (Canada only)	51.42%	47.41%

MINIMUM FIREPLACE OPENING (VIGNETTE FACEPLATE)	
Width (front)	26-1/2"
Width (rear)	22-1/2"
Height	21"
Depth (without spacer)	--
Depth (with spacer)	15"



U31 shown with Low Profile faceplate and brick panels.

STANDARD FEATURES

- Natural gas
- Safety screen
- Ceramic safety glass
- Proflame I GT remote control
- Log set with glowing embers
- Flame height adjustment control
- Variable speed blower
- Standing pilot system
- Direct spark ignition
- B vent
- Installation spacer
- Limited lifetime warranty

OPTIONS

- Low profile faceplates
- Custom backing plate
- Contour faceplate
- Hearth trim kit
- Black louvers
- Brick panels
- Basic or programmable wall thermostat
- Regency flex liners
- Propane conversion kit

REGENCY LIBERTY® L234

Small Gas Fireplace Insert



L234 shown with Low Profile faceplate and brick panels.

COMPACT SIZE FOR TIGHTER OPENINGS

Designed to fit smaller openings in existing masonry fireplaces, and inefficient steel fireplaces, the L234 small gas insert delivers efficient heat with stylish good looks. Highly realistic logs make this quality, small gas insert an excellent choice for small to medium size spaces.

SPECIFICATIONS	NATURAL GAS	PROPANE
Input (BTU)	23,500	21,500
Turn down to (BTU)	16,500	17,000
Efficiency (steady state)	73.94%	74.67%
EnerGuide Rating (Canada only)	63.34%	64.73%

MINIMUM FIREPLACE OPENING (VIGNETTE FACEPLATE)	
Width (front)	25"
Width (rear)	16"
Height	17"
Depth (without spacer)	14"
Depth (with spacer)	--

Note: This unit is only available in select markets.



L234 shown with Low Profile faceplate and brick panels.

STANDARD FEATURES

- Natural gas
- Safety screen
- Ceramic safety glass
- Proflame I GTM remote control
- Log set with glowing embers
- 30° angled flue for versatile installation
- Variable speed blower
- Installation spacer
- Flame height adjustment control
- Standing pilot system with 7-Day timed shut off
- Direct spark ignition
- Direct vent
- Limited lifetime warranty

OPTIONS

- Low profile faceplate
- Custom backing plate
- Adjustable hearth riser
- Brick panels
- Basic or programmable thermostat
- 3" to 2" air intake reducer
- Regency flex liners
- Propane conversion kit

BACKING PLATES, FACEPLATES & INLAYS

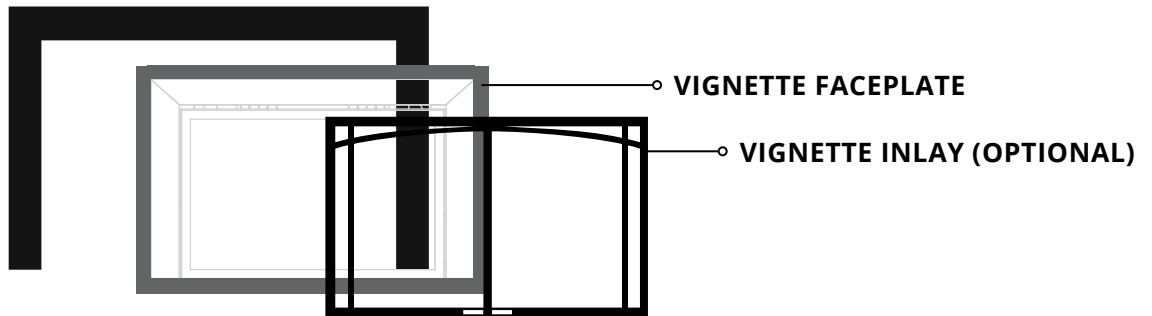

BACKING PLATE OPTIONS*



Small Backing Plate

Arched Backing Plate

Regular Backing Plate

4-sided Regular Backing Plate

Oversized Backing Plate

*Custom sizes also available

VIGNETTE FACEPLATE OPTIONS (NOT AVAILABLE ON ALL MODELS)

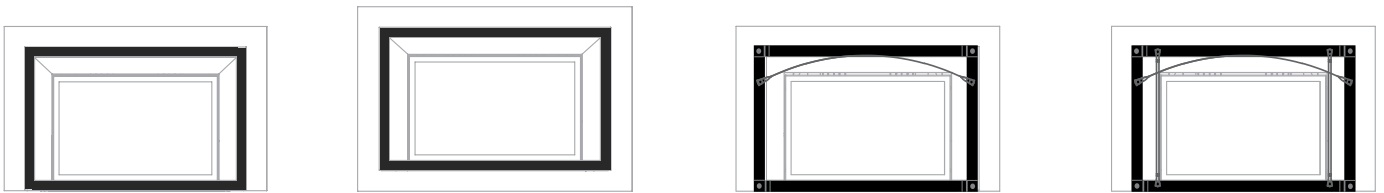

Vignette with 3-sided Backing Plate

Vignette with 4-sided Backing Plate

Georgian Rustic Vignette Faceplate

Tudor Rustic Vignette Faceplate

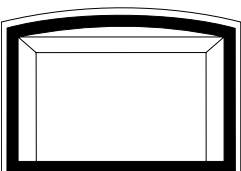

Arched Vignette Faceplate

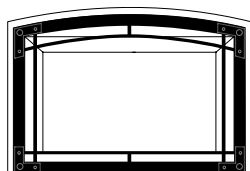

Decorative Arched Vignette Faceplate

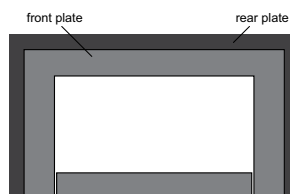

Low Profile Faceplate

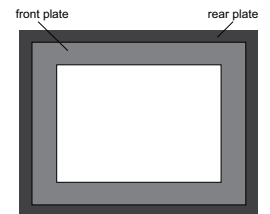

Low Profile Faceplate (4-sided)

VIGNETTE INLAY OPTIONS



Vignette Door Inlay**

Vignette Craftsman Inlay**

**LR13E/HRI3E Inlay designs are not exactly as shown

VIGNETTE FACEPLATE & VIGNETTE INLAY FINISHES



Black

Black Chrome

Tuscan Sunset

Platinum
(Not available
for inlays)

Iron Grey
(Only available for
Georgian & Tudor
Vignette Faceplates)

OPTIONS

FACEPLATE OPTIONS

Vignette faceplate shown with regular backing plate

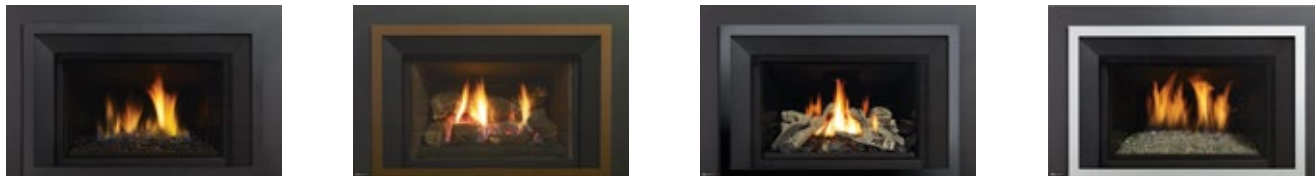

Vignette faceplate shown with 4-sided regular backing plate



Georgian rustic Vignette faceplate



Tudor rustic Vignette faceplate



Arched Vignette faceplate



INLAY OPTIONS

Vignette door inlay



Vignette craftsman inlay



FINISHING OPTIONS

CRYSTALS & FIREBEADS

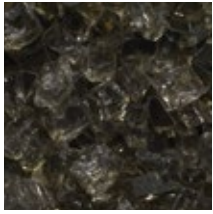

Crystals - Black

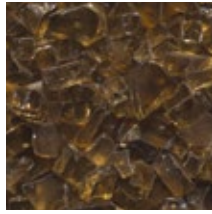

Crystals - Copper

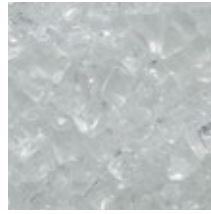

Crystals - Starfire



Firebeads - Black

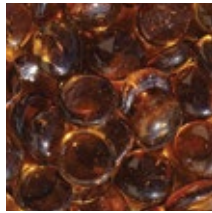

Firebeads - Caramel Luster



Firebeads - Glacier Ice

STONES & LOGS



Volcanic Stones - Gray



Volcanic Stones - Tan



Ceramic Spa Stones



Natural River Pebbles



Driftwood
Ceramic Log Set

INNER PANELS



Reflective
Black Enamel Panels



Standard - Rustic Brown

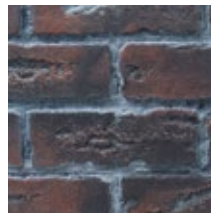

Standard - Old Town Red

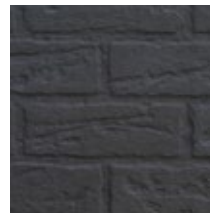

Standard - Volcanic Black



Black Steel
*(Only Available for
LRi4E and HRi4E)*

ACCESSORIES

ACCESSORIES - AT A GLANCE			LRI3E	HRI3E	LRI4E	HRI4E	LRI6E	HRI6E	E33	U31	L234	
Horizon firebed	Crystals in various colors		•	★	•	★	•	★	•	•	•	
	Firebeads in various colors		•	★	•	★	•	★	•	•	•	
	Ceramic spa stones		•	★	•	★	•	★	•	•	•	
	Volcanic stones		•	★	•	★	•	★	•	•	•	
	Driftwood log set (natural gas only on HRI4E & HRI6E)		•	★	•	★	•	★	•	•	•	
Backing plates	Small		★	★	★	★	★	★	•	•	•	
	Regular		★	★	★	★	★	★	•	•	•	
	4-sided regular		★	★	★	★	★	★	•	•	•	
	Oversized		★	★	★	★	★	★	•	•	•	
	Arched		★	★	★	★	★	★	•	•	•	
Vignette faceplates	Vignette	Black	★	★	★	★	★	★	•	•	•	
		Black chrome	★	★	★	★	★	★	•	•	•	
		Platinum	★	★	★	★	★	★	•	•	•	
		Tuscan sunset	★	★	★	★	★	★	•	•	•	
	Vignette – 4-sided	Black		•	•	•	•	•	•	★	•	•
		Rustic Vignette	Georgian	Black	★	★	★	★	★	★	•	•
	Iron grey		★	★	★	★	★	★	•	•	•	
	Tudor		Black	★	★	★	★	★	•	•	•	
	Iron grey	★	★	★	★	★	★	•	•	•		
	Arched Vignette	Arched	Black	★	★	★	★	★	•	•	•	
		Decorative Arched	Black	★	★	★	★	★	•	•	•	
	Vignette inlays	Door inlay	Black	★	★	★	★	★	★	★	•	•
Black chrome			★	★	★	★	★	★	★	•	•	
Tuscan sunset			★	★	★	★	★	★	★	•	•	
Craftsman inlay		Black	★	★	★	★	★	★	•	•	•	
		Black chrome	★	★	★	★	★	★	•	•	•	
		Tuscan sunset	★	★	★	★	★	★	•	•	•	
Low profile faceplates	Low profile – 3-sided	Black	•	•	•	•	•	•	★	★	★	
	Low profile – 3-sided – oversize	Black	•	•	•	•	•	•	★	•	•	
	Low profile – 3-sided – custom	Black	•	•	•	•	•	•	★	★	★	
Contour faceplate	Black		•	•	•	•	•	•	•	★	•	
Louvers	Black		•	•	•	•	•	•	•	★	•	
Inner panels	Bricks	Rustic brown	★	•	★	•	★	•	★	★	★	
		Old town red	★	•	★	•	★	•	★	★	★	
		Volcanic black	★	•	★	•	★	•	•	•	•	
	Steel	Black		•	✓	★	★	✓	✓	✓	✓	
	Reflective	Black enamel		★	★	★	★	★	★	•	•	•
Safety screen			✓	✓	✓	✓	✓	✓	✓	✓	✓	
Spacer			•	•	★	★	★	★	•	•	✓	
Hearth trim			★	★	★	★	★	★	★	★	★	
Variable speed blower			✓	✓	✓	✓	✓	✓	✓	✓	✓	
Wall thermostat			★	★	★	★	★	★	★	★	★	
Remote control	Proflame GT		•	•	•	•	•	•	•	✓	•	
	Proflame GTM		•	•	•	•	•	•	✓	•	✓	
	Proflame GTMF		✓	✓	✓	✓	✓	✓	•	•	•	
Turn down flame modulator			✓	✓	✓	✓	✓	✓	✓	✓	✓	
Direct vent			✓	✓	✓	✓	✓	✓	✓	•	✓	
B-Vent			•	•	•	•	•	•	•	✓	•	
Intelligent Ignition system			✓	✓	✓	✓	✓	✓	•	•	•	
Propane conversion kit			★	★	★	★	★	★	★	★	★	

• Not available

✓ Standard

★ Optional

NOTE: All product specifications are subject to change without notice. Before installing refer to the relevant product manual for full and up to date information.

OTHER OPTIONS

MAXIMIZING COMFORT AND EFFICIENCY

Regency Fireplace Inserts deliver controllable heat solutions that combine the latest in radiant and convection heat technology with innovative features:

- Adjustable flame/heat control with Proflame remote controls (not available for U31)
- Heat radiating ceramic glass for maximum radiant heat
- Safety screen
- Variable speed blower to distribute heat into the farthest corners of your room
- Intelligent Ignition System* features fuel-saving intermittent pilot ignition (IPI), 7-day continuous pilot mode (CPI), and 5 second Flame Failure Response Time (FFRT) for more reliable startups - even in cold weather
- Power's Out, Heat's On. Never worry about being cold during a power outage again! All Regency gas fireplaces operate without electricity. Enjoy peace of mind all winter long.

*Not available for L234, U31, E33.

REMOTE CONTROL - INCLUDED



Proflame I GTMF Remote Control



Proflame II GTMF Remote Control

Create optimal comfort with ease and convenience at the touch of a button with a Regency remote control. Our **user-friendly programmable controls** can be set, adjusted, and programmed for your fireplace to turn on at the temperature you want, when you want it.

FEATURE	DESCRIPTION	PROFLAME REMOTES		
		GT	GTM	GTMF
On/off		✓	✓	✓
Child lock		✓	✓	✓
LCD backlit screen		✓	✓	✓
Temperature display	°F / °C	✓	✓	✓
Thermostat	one setting (all days)	✓	✓	✓
Smart thermostat**		✓	✓	✓
Flame adjustment	(6 levels)	•	✓	✓
Fan control	(6 levels)	•	•	✓

- Not available
- ✓ Standard

**Smart Thermostat - Rather than a thermostat that simply turns your fireplace on and off, the smart control function allows you to set your desired room temperature. As the room reaches your personal setting, the flame intensity and heat will gradually decrease - keeping the ambiance of your Regency fire on with less heat output, and the option to turn it off at any time.

SAFETY SCREEN

Regency has integrated a custom designed safety screen into each faceplate design that meets or exceeds current North American safety legislation.

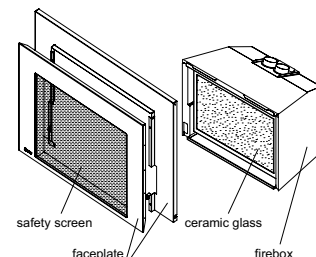

DIRECT VENT TECHNOLOGY

Regency gas insert is a specially engineered, sealed fireplace that slips into your existing masonry or pre-fab fireplace to create a high-efficiency heating system with a beautiful fire. The airtight firebox uses outside air for combustion, helping maintain indoor air quality and keeping all the warmth generated from your fireplace in your home.

Even when the fireplace is turned off, the sealed system will prevent cold air from entering the home and warm air from leaving.

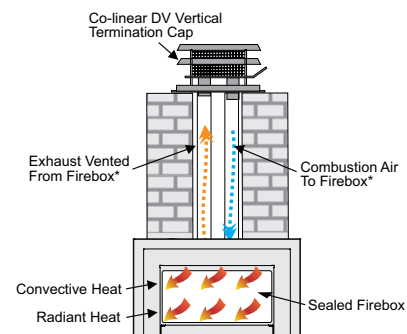

*May be reversed on certain models.

INTELLIGENT IGNITION SYSTEM*

The Intelligent Ignition System included in Regency gas fireplace inserts helps save you money while maintaining fireplace reliability and performance. It does this by ensuring the pilot light is lit only when it is needed. With intermittent pilot ignition (IPI), the pilot light is lit only before the fireplace is used.

For colder climates, the fireplace can also be set to **continuous pilot mode (CPI)**, where the pilot will stay lit for up to 7 full days between uses. With a new 5 second **Flame Failure Response Time (FFRT)** sensor, the ability to light the pilot light the first time is improved drastically, especially in cold climates. Experience increased reliability, performance and lower gas bills with the intelligent ignition system from Regency.

*Not available on L234, U31, E33.

SPREAD THE WARMTH

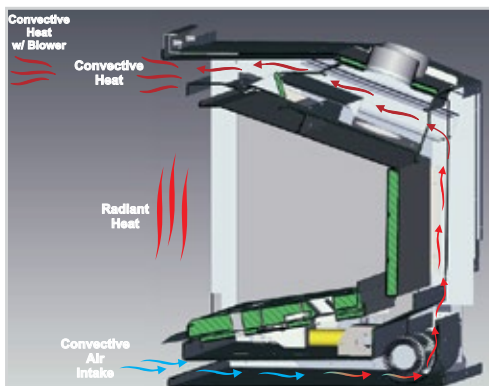

Blower

REMARKABLE EFFICIENCY

The precision-engineered heat exchanger systems dramatically increase the overall heating efficiency of these Regency gas inserts. The cold air from your room passes through the pre-heated heat exchanger system, which is then re-distributed back into your room as comforting warm air (also known as convection heat).

POWERFUL RADIANT HEAT

Not only do these gas inserts include the latest innovations in fireplace technology and efficiencies, they also generate a large amount of radiant heat from the flames and glow of the fire package. The heat from the fire radiates through the ceramic glass and transfers that warmth to you, providing the perfect combination of radiant and convective heat distribution.

VARIABLE SPEED BLOWER TO MAXIMIZE EFFICIENCY

Regency blowers are a standard feature with all gas inserts. A blower will let you enjoy the warmth of your fireplace from any corner of your living space. Our quiet blowers increase the efficiency of your fireplace by pushing the heat produced by your fireplace forward, distributing it further, and evenly into your room.

DIMENSIONS

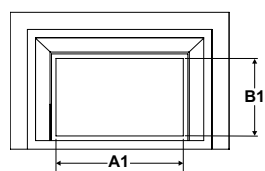

FRONT VIEW

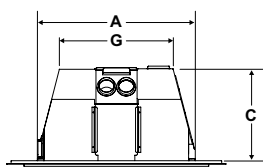

TOP VIEW

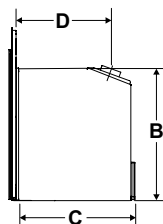

SIDE VIEW OF HRI6E,
LRI6E, HRI4E, LRI4E,
HRI3E, LRI3E, E33, L234

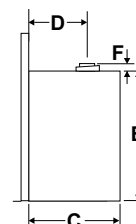

SIDE VIEW
OF U31

UNIT	A	B	A1	B1	C	D	F	G
HRI6E	33-15/16"	23-5/8"	28-3/16"	18-5/16"	19-3/16"	14-11/16"	--	24-1/2"
LRI6E	33-15/16"	23-5/8"	28-3/16"	18-5/16"	19-3/16"	14-11/16"	--	24-1/2"
HRI4E	30"	20"	24-3/16"	14-3/4"	17-7/8"	14-5/16"	--	21-11/16"
LRI4E	30"	20"	24-3/16"	14-3/4"	17-7/8"	14-5/16"	--	21-11/16"
HRI3E	28"	19"	22-11/16"	14-1/4"	14"	10-3/8"	--	21-1/4"
LRI3E	28"	19"	22-11/16"	14-1/4"	14"	10-3/8"	--	21-1/4"
E33	32-1/4"	23-3/4"	30-3/8"	14-3/4"	16-1/4"	11-1/16"	--	24-1/2"
U31	26-1/16"	20-1/4"	24-1/2"	13"	13-1/2"	11"	11/16"	22-1/2"
L234	24-3/4"	16-7/8"	17-3/4"	12-1/2"	14-11/16"	11-3/4"	--	14-3/4"

BACKING PLATE DIMENSIONS

BACKING PLATE	HRI6E		LRI6E		HRI4E		LRI4E		HRI3E		LRI3E	
	WIDTH	HEIGHT	WIDTH	HEIGHT	WIDTH	HEIGHT	WIDTH	HEIGHT	WIDTH	HEIGHT	WIDTH	HEIGHT
Small	41"	27-3/4"	41"	27-3/4"	37-1/8"	23-5/8"	37-1/8"	23-5/8"	31-1/4"	23-3/8"	31-1/4"	23-3/8"
Regular (3-sided)	47-3/8"	30-1/2"	47-3/8"	30-1/2"	41-5/8"	26"	41-5/8"	26"	35-3/4"	25-5/8"	35-3/4"	25-5/8"
Regular (4-sided)	47-3/8"	34-1/8"	47-3/8"	34-1/8"	41-5/8"	29-1/4"	41-5/8"	29-1/4"	35-3/4"	28-5/8"	35-3/4"	28-5/8"
Oversized	48-3/8"	33"	48-3/8"	33"	44"	30"	44"	30"	38-3/16"	29-5/8"	38-3/16"	29-5/8"
Custom Backing Plate	Custom Order Only											

BACKING PLATE	HRI6E/LRI6E			HRI4E/LRI4E			HRI3E/LRI3E		
	WIDTH	CENTRE HEIGHT	CORNER HEIGHT	WIDTH	CENTRE HEIGHT	CORNER HEIGHT	WIDTH	CENTRE HEIGHT	CORNER HEIGHT
Arched	50-7/8"	33-1/16"	29-13/16"	45-7/8"	28-15/16"	25-15/16"	40-15/16"	27-11/16"	24-1/2"

NOTE: All product specifications are subject to change without notice.
Always refer to the relevant product manual for full and up-to-date information.

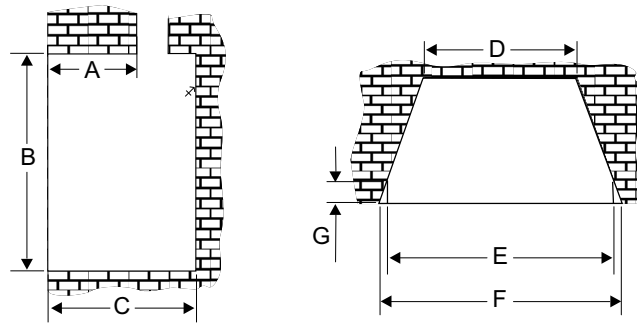

MINIMUM FIREPLACE OPENINGS		A	B	C	D	E	F	G
HRI6E	Vignette Faceplate	12-1/2"	24"	19-1/2"	25"	34"	37"	4-3/4"
	Vignette Faceplate + Spacer	10"	24"	16-3/4"	25"	34"	35-3/8"	2-1/4"
	Arched Vignette Faceplate	13-1/2"	25-3/4"	22-3/8"	25"	35-3/4"	37"	6"
	Arched Vignette Faceplate + Spacer	12"	24"	19-1/2"	25"	34"	36-1/4"	4-3/4"
LRI6E	Vignette Faceplate	12-1/2"	24"	19-1/2"	25"	34"	37"	4-3/4"
	Vignette Faceplate + Spacer	10"	24"	16-3/4"	25"	34"	35-3/8"	2-1/4"
	Arched Vignette Faceplate	13-1/2"	25-3/4"	22-3/8"	25"	35-3/4"	37"	6"
	Arched Vignette Faceplate + Spacer	12"	24"	19-1/2"	25"	34"	36-1/4"	4-3/4"
HRI4E	Vignette Faceplate	12-1/4"	20"	18"	22"	30"	35-5/8"	4-3/8"
	Vignette Faceplate + Spacer	10"	20"	15-3/4"	22"	30"	31-1/4"	2-1/8"
	Arched Vignette Faceplate	14"	21-1/2"	21-1/8"	22"	30-1/2"	37"	5-3/8"
	Arched Vignette Faceplate + Spacer	12-1/2"	20"	17-1/2"	22"	30"	36-1/4"	4"
LRI4E	Vignette Faceplate	12-1/4"	20"	18"	22"	30"	35-5/8"	4-3/8"
	Vignette Faceplate + Spacer	10"	20"	15-3/4"	22"	30"	31-1/4"	2-1/8"
	Arched Vignette Faceplate	14"	21-1/2"	21-1/8"	22"	30-1/2"	37"	5-3/8"
	Arched Vignette Faceplate + Spacer	12-1/2"	20"	17-1/2"	22"	30"	36-1/4"	4"
HRI3E	Vignette Faceplate	8-5/8"	19-1/2"	14-1/2"	21-5/8"	28-1/2"	31-1/8"	4"
	Arched Vignette Faceplate	8-5/8"	19-1/2"	14-1/2"	21-5/8"	28-5/8"	31-1/8"	4"
LRI3E	Vignette Faceplate	8-5/8"	19-1/2"	14-1/2"	21-5/8"	28-1/2"	31-1/8"	4"
	Arched Vignette Faceplate	8-5/8"	19-1/2"	14-1/2"	21-5/8"	28-5/8"	31-1/8"	4"
E33	Low Profile Faceplate	9-1/4"	25-1/2"	18"	25"	N/A	35-1/4"	N/A
	Low Profile Faceplate + Spacer	8"	24-3/16"	16-3/4"	25"	N/A	32-1/4"	N/A
U31	Low Profile Faceplate	8-1/8"	21"	15"	22-1/2"	N/A	26-1/2"	N/A
L234	Low Profile Faceplate	N/A	17"	14" (with spacer) 15-5/8" (without spacer)	16"	N/A	25"	N/A

A - Max. lintel bar depth
G - Front depth prior to taper

NOTE: All product specifications are subject to change without notice.
Always refer to the relevant product manual for full and up-to-date information.

DIMENSIONS

FACEPLATES	HRI6E		LRI6E		HRI4E		LRI4E		HRI3E		LRI3E	
	WIDTH	HEIGHT	WIDTH	HEIGHT	WIDTH	HEIGHT	WIDTH	HEIGHT	WIDTH	HEIGHT	WIDTH	HEIGHT
Vignette and Rustic Vignette	40-1/16"	26-13/16"	40-1/16"	26-13/16"	35-1/16"	22-11/16"	35-1/16"	22-11/16"	29-1/4"	22-1/8"	29-1/4"	22-1/8"
Vignette Spacer	39-15/16"	26-3/4"	39-15/16"	26-3/4"	34-15/16"	22-5/8"	34-15/16"	22-5/8"	--	--	--	--
Hearth Trim - Sizes	Please See Manual For Details											

FACEPLATES	HRI6E/LRI6E			HRI4E/LRI4E			HRI3E/LRI3E		
	WIDTH	CENTRE HEIGHT	CORNER HEIGHT	WIDTH	CENTRE HEIGHT	CORNER HEIGHT	WIDTH	CENTRE HEIGHT	CORNER HEIGHT
Arched Vignette	45-3/8"	30-7/16"	27-13/16"	40-1/4"	26-1/8"	23-3/4"	35-15/16"	25-3/16"	22-3/4"
Spacer	45-3/8"	30-7/16"	27-13/16"	40-1/4"	26-1/8"	23-3/4"	--	--	--

FACEPLATES	E33		U31		L234		
	WIDTH	HEIGHT	WIDTH	HEIGHT	WIDTH	HEIGHT	
Vignette (3-Sided)	46-1/2"	28-3/4"	--	--	--	--	
Vignette (4-Sided)	46-1/2"	30-7/8"	--	--	--	--	
Custom Faceplate (3-Sided Vignette Only)	Custom Order Only		--	--	--	--	
Spacer (3-Sided Vignette Only)	45"	28"	--	--	--	--	
Low Profile (3-Sided)	Front Plate	42-7/16"	26-3/4"	36"	22-1/8"	29-1/8"	21"
	Rear Plate	46-1/2"	28-11/16"	40-13/16"	24"	32-7/8"	22-7/8"
Low Profile (3-Sided Oversize)	Front Plate	42-7/16"	26-3/4"	--	--	--	--
	Rear Plate	49-9/16"	33-1/8"	--	--	--	--
Low Profile (3-Sided) Custom	Rear Plate	Custom Order Only					
Low Profile (4-Sided) Custom	Rear Plate	Custom Order Only					
Hearth Trim - Sizes	Please See Manual For Details						

MINIMUM CLEARANCE TO COMBUSTIBLES		HRI6E	LRI6E	HRI4E	LRI4E	HRI3E	LRI3E	E33	U31	L234
A	Side Wall	12"	12"	8"	8"	6"	6"	8"	10"	8"
B	Ceiling	60"	60"	60"	60"	60"	60"	72"	67"	73"
C	Mantel Height (Min.)	40"	40"	35"	35"	38"	38"	40"	32-1/2"	38"
	(With Optional Deflector)	36"	36"	32"	32"	28"	28"	N/A	N/A	N/A
D	Mantel Depth (Min.)	1"	1"	1"	1"	1"	1"	0 - 3-1/2"	0 - 3-1/2"	1"
	(With Optional Deflector)	1"	1"	1"	1"	1"	1"	N/A	N/A	N/A
E	Alcove Width	56"	56"	54"	54"	54"	54"	76"	48"	60"
F	Max. Alcove Depth	36"	36"	36"	36"	36"	36"	36"	36"	36"

NON-COMBUSTIBLE HEARTH REQUIREMENT										
G	Hearth Height	1-3/8"	1-3/8"	1/2"	1/2"	1/2"	1/2"	1-1/4"	0"	1-1/2"
H	Hearth Width	44"	44"	40"	40"	36"	36"	45-1/2"	0"	28"
I	Hearth Depth	14"	14"	14"	14"	12"	12"	13"	0"	12"

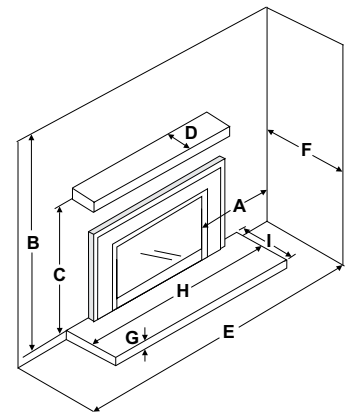

NOTE: All product specifications are subject to change without notice. Always refer to the relevant product manual for full and up-to-date information.

FIREPLACE SELECTION WORKSHEET

We want you to enjoy your beautiful Regency fireplace for years to come. To help you figure out which product is just right for your home, fill in the following worksheet. Once complete, visit your nearest Regency dealer. Your professional Regency dealer will assess your needs - including local building codes - and install your Regency.

1. BASIC PRODUCT FUNCTION QUESTIONS

a. I would like my unit to provide me with: Supplemental heating Priority heating

b. The room/rooms I would like to heat are: _____ sq. ft.

2. FIREPLACE PRODUCT TYPE AND MEASUREMENTS

a. I am: Installing a new fireplace Installing into an existing fireplace

b. Fill in the following measurements: Ceiling Height: _____

Location in the room: _____

c. What is the: Flooring material: _____

Wall material: _____

Ceiling material: _____

d. Fireplace opening dimensions: Width (front): _____

Width (back): _____

Height: _____

Depth: _____

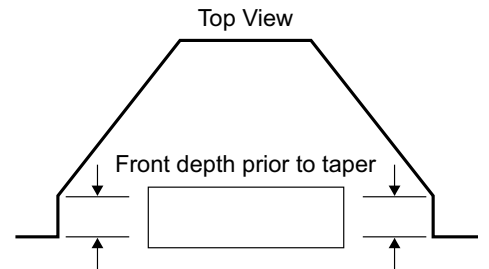
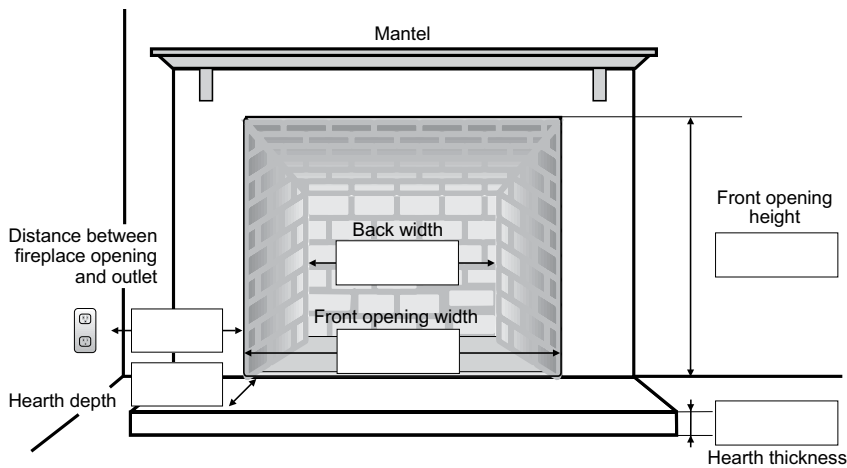
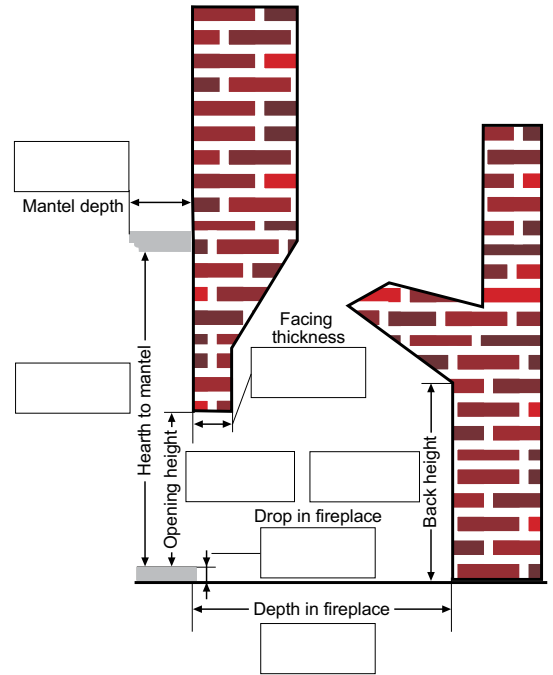



Find More Products at [REGENCY-FIRE.COM](https://www.regency-fire.com)

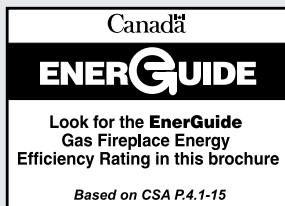

©2022 FPI Fireplace Products International Ltd. Regency®, Regency Liberty®, Regency Horizon®, Regency Energy™ and Surefire™ are registered or proprietary trademarks of FPI Fireplace Products International Ltd. All rights reserved.
Printed in Canada (04/22)
Part no. 944-072

Your Regency Dealer